

FloPlast
building the future

Roofline, Window and Cladding Systems



www.floplast.co.uk



Introduction to FloPlasts Roofline, Window and Cladding Systems

FloPlast, a name synonymous with high quality PVC-UE roofline products for new build and home improvement projects, with its wide range of rainwater systems, cellular foam and rigid PVC-UE building profiles.

FloPlasts has rainwater Systems include **Half Round**, **Square Line** and **MiniFlo** and are complemented with the choice of three high capacity systems:-

Hi-Cap, a semi-elliptical profile with a high capacity suitable for large roof areas.

Niagara Ogee, a traditional ogee style profile - probably the highest capacity domestic PVC-U Rainwater System on the market.

XtraFlo, a 170mm semi-elliptical System, for large Commercial/Industrial buildings, which links to a 110mm downpipe system.

A comprehensive selection of co-extruded cellular foam and rigid PVC-UE building profiles completes the FloPlast range of Roofline products.

FloPlast Roofline, Window and Cladding extrusions are manufactured on state of the art machinery and extrusion dies at the group's Cork plant, which has over 40 years extrusion experience behind it.

For CE DOP's (Declaration of Performance), please refer to our website at www.floplast.co.uk.

FloPlast operations embrace quality, environment and energy management systems which have been accredited by BSI to
BS EN ISO 9001:2015 Certificate No. FM 501414,
BS EN ISO 14001:2015 Certificate No. EMS 538445,
BS EN ISO 45001:2018 Certificate No. OHS 593622 and
ISO 50001:2011 Certificate No. ENMS 638370.



Both the white roof trim and white cladding systems have been assessed and achieved Agrément Certification as follows:-



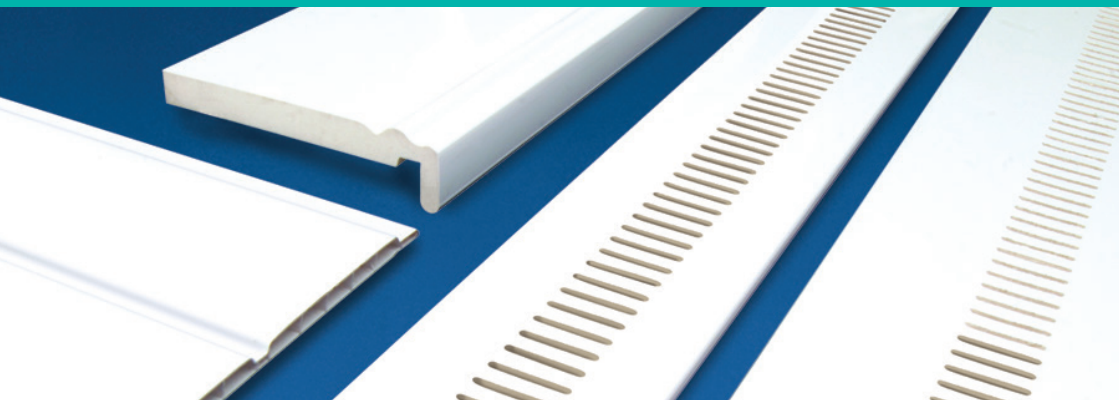

Features and Guarantee

Maintenance - Will not rot, warp, crack or erode.

They do not require painting or any other protective treatment. To restore to an 'as new' surface appearance, occasional washing with a non-scratch mild detergent and water will remove surface grime particularly in polluted atmosphere.

Weather resistance - The impermeable outer skin and closed-cell composition of the boards are unaffected by moisture and will not rot or corrode.

Durability - The combined cellular core and Co-extruded PVC-U surface skin ensure high durability in all conditions.

Thermal efficiency - Good insulating properties, improves overall thermal insulation of composite wall construction.

Compatibility - No chemical reaction with other common building materials.

Workable - Cutting, drilling, nailing and shaping are easily achieved.

Finish - High gloss finish with blemish free surface.

Guarantee - FloPlast Co-extruded White Cellular and Woodgrain PVC-UE boards come with a 20 year product guarantee for white roofline and a 10 year product guarantee for laminate roofline in respect of performance and significant discolouration. The guarantee is subject to registration of the installation. Full details of the guarantee are available upon request.

Behaviour in relation to fire:

Boards - The cellular boards achieve a Class 2Y surface-spread-of-flame rating when tested in accordance with BS 476-7.

Hollow Soffit - The hollow soffits achieve a Class 1Y surface-spread-of-flame rating when tested in accordance with BS 476-7.

Foiled Products - The Renolit foil applied to FloPlast's cladding, boards or hollow soffit systems has been tested and achieved the following fire rating:

When tested in accordance with DIN4012-B2 and DIN EN ISO13501-1, the requirements according to RAL-GZ716/1 Section I Part 7 are fully met.

General - On exposure to fire, PVC-U tends to char and may fall away. The spread of flame along its surface is limited. It is unlikely that the roof trim system will significantly affect the overall fire performance of any roof in which it is installed.

Where it is normal practice to carry the eaves box over, between dwellings, it is important that the box is fire-stopped at compartment walls with a proprietary fire stop material.

For more information please refer to our BBA certificate 00/3771 and 00/3772.



White PVC-UE Roofline Board

Fascia, Soffit, Bargeboard and Trims

FloPlast offer a range of Fascia Boards for use in both new build work, total replacement or refurbishment by covering existing timber. The range of fascia profiles comprise:

- A traditional 9mm Universal Board which requires a backing board.
- An Ogee Fascia Board which offers an attractively designed alternative to the Universal Board.
- An 18mm Mammoth Board which does not require a backing board to support it, because of its rigid linear strength, and thickness. This makes it extremely suitable for total replacement and new build applications when it is fixed directly to the rafter ends.
- Ogee Mammoth Board which again offers the attractive alternative to the plain mammoth board.

A range of matching PVC-U mouldings caters for all joints and corners.

Soffits can be formed using a number of options:

- Multi-Purpose Board up to a width of 600mm combined with Soffit Vent Strip or Circular Disc Ventilators.
- Pre-vented Soffit Board with air slots to provide ventilation to a 10mm or 25mm wide clear air gap, which conform to current building regulations.
- Cladded Soffit using the 150mm Shiplap Cladding or 100mm V Joint Cladding to give an attractive ribbed effect.
- Rigid PVC-U Hollow Soffit in 300mm widths provide a cost competitive and effective alternative to cellular boards. These should not be used as an external cladding system.

| Product | Size | Code |
|---------|------|------|
|---------|------|------|

Universal Board - 9mm

Suitable as fascia (refurbishment - install over timber support), window board or reveal liner.

| | | | |
|---|-------------|-------|------|
|  | Single Leg: | 100mm | U100 |
| | | 150mm | U150 |
| | | 175mm | U175 |
| | | 200mm | U200 |
| | | 225mm | U225 |
| | | 250mm | U250 |
| | 275mm | U275 | |
| | 300mm | U300 | |
| Double Leg: | | 354mm | U350 |
| | | 450mm | U450 |

Square Edge Universal Board - 9mm

Suitable as fascia (refurbishment - install over timber support), window board or reveal liner.

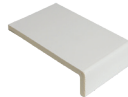
| | | | |
|---|-------------|-------|------|
|  | Single Leg: | 150mm | L150 |
| | | 175mm | L175 |
| | | 200mm | L200 |
| | | 225mm | L225 |
| | | 250mm | L250 |
| Double Leg: | 400mm | L400 | |

Ogee Fascia Board - 10mm

Suitable as fascia (refurbishment - install over timber support).

| | | | |
|---|-------------|-------|------|
|  | Single Leg: | 150mm | O150 |
| | | 175mm | O175 |
| | | 200mm | O200 |
| | | 225mm | O225 |
| | | 250mm | O250 |
| Double Leg: | 404mm | O404 | |

| Product | Size | Code |
|---------|------|------|
|---------|------|------|

Box End Boards

| | | |
|--------------------|-------|-------|
| Universal Board | 454mm | UB454 |
| Mammoth Board | 404mm | MB404 |
| Ogee Mammoth Board | 454mm | GB454 |

ROOFLINE, WINDOW & CLADDING SYSTEMS



White PVC-UE Roofline Board, Soffit & Fixings

| Product | Size | Code |
|---------|------|------|
|---------|------|------|

Mammoth Board - 18mm

Suitable as fascia (replacement/new build install direct to rafters), window board or reveal liner.

Single Leg:

| | |
|-------|------|
| 150mm | M150 |
| 175mm | M175 |
| 200mm | M200 |
| 225mm | M225 |
| 250mm | M250 |
| 300mm | M300 |

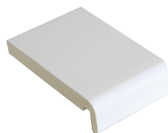

Double Leg:

| | |
|-------|------|
| 404mm | M404 |
|-------|------|

Ogee Mammoth Board - 18mm

Suitable as fascia (replacement/new build, install direct to rafters).

Single Leg:

| | |
|-------|------|
| 150mm | G150 |
| 175mm | G175 |
| 200mm | G200 |
| 225mm | G225 |
| 250mm | G250 |
| 300mm | G300 |



Double Leg:

| | |
|-------|------|
| 454mm | G454 |
|-------|------|

Multi-Purpose Soffit Board - 10mm

Single Round Edge:

| | |
|-------|------|
| 100mm | S100 |
| 150mm | S150 |
| 175mm | S175 |
| 200mm | S200 |
| 225mm | S225 |
| 250mm | S250 |
| 500mm | S500 |



Double Round Edge:

| | |
|-------|------|
| 304mm | S304 |
| 404mm | S404 |
| 600mm | S600 |

Hollow Soffit

To be used as a soffit only.

| | |
|-------|------|
| 300mm | H300 |
|-------|------|

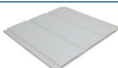

| Product | Size | Code |
|---------|------|------|
|---------|------|------|

Hollow Soffit Trims

| | | |
|---|-----|----|
|  | 'J' | HJ |
|  | 'H' | HH |

Vented Soffit - 10mm

| | | |
|---|-------|------|
|  | 100mm | V100 |
| | 150mm | V150 |
| | 175mm | V175 |
| | 200mm | V200 |
| | 225mm | V225 |
| | 250mm | V250 |
| | 304mm | V304 |
| | 404mm | V404 |
| 500mm | V500 | |
| 600mm | V600 | |

Double Vented Soffit - 10mm

| | | |
|--|-------|-------|
|  | 175mm | DV175 |
| | 200mm | DV200 |
| | 250mm | DV250 |
| | 304mm | DV304 |
| | 404mm | DV404 |

Vented soffit with a double row of vents is available for special order.

FloTop Pins

| | | |
|---|------|------|
|  | 30mm | FP30 |
| | 40mm | FP40 |

FloTop Nails



| | | |
|---|------|------|
|  | 50mm | FN50 |
| | 65mm | FN65 |

Clad Pins

| | | |
|---|------|------|
|  | 30mm | CP30 |
| | 50mm | CP50 |







White Roofline Joints and Trims

| Product | Size | Code |
|--|--------------|------|
| In-Line Joints | | |
|  | 300x42mm Leg | RT1 |
|  | 500x35mm Leg | RT2* |
|  | 500x42mm Leg | RT3* |

*Double ended joint - cut to 2 sizes as required. To be used with Mammoth Board.

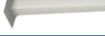

†Double ended joint - cut to 2 sizes as required. To be used with Universal Board.



| Product | Size | Code |
|--|-------------------------------------|------|
| Corner Joints | | |
|  | 300x42mm Leg | RT4 |
|  | 500x35mm Leg | RT5* |
|  | 500x42mm Leg | RT6† |
|  | 300x42mm Leg Internal Corner | RT7 |
|  | 300x42mm Leg External Corner 135 | RT10 |

*Double ended joint - cut to 2 sizes as required. To be used with Mammoth Board.



†Double ended joint - cut to 2 sizes as required. To be used with Universal Board.

| Product | Size | Code |
|--|--------------|------|
| Square In-Line Joints | | |
|  | 300x42mm Leg | RT16 |

| Product | Size | Code |
|--|---------------------------------|------|
| Square Corner joints | | |
|  | 300x42mm Leg | RT13 |
|  | 300x42mm Leg Internal Corner | RT18 |

| Product | Size | Code |
|--|----------|-------|
| Ogee In-Line Joints | | |
|  | 300x50mm | RT11 |
|  | 500x50mm | RT12* |



*Double ended ogee joint - cut to 2 sizes as required.

| Product | Size | Code |
|--|--------------------------------------|-------|
| Ogee Corner Joints | | |
|  | 300x50x50mm | RT14 |
|  | 500x50x50mm | RT15* |
|  | 300x42mm leg Ogee Internal Corner | RT17 |

*Double ended ogee joint - cut to 2 sizes as required.

| Product | Size | Code |
|---|----------|------|
| Ogee Box End Cover | | |
|  | 404x60mm | RT19 |

| Product | Size | Code |
|---|-------|------|
| Bargeboard Moulding Trim | | |
|  | 500mm | RT22 |

| Product | Size | Code |
|---|-------|------|
| Finials | | |
|  | 340mm | RT23 |
|  | 900mm | RT29 |

| Product | Size | Code |
|---|---------------|------|
| Disc Soffit Ventilator | | |
|  | 75mm Diameter | RT25 |

| Product | Size | Code |
|---|------|------|
| In-Line Jointing Trim | | |
|  | | RT20 |

| Product | Size | Code |
|---|------|------|
| Edge Capping Trims | | |
|  | | RT21 |

| Product | Size | Code |
|--|------|------|
| Soffit Ventilator | | |
|  | | RT24 |

| Product | Size | Code |
|---|-----------------|------|
| Soffit Ventilator with Mesh | | |
|  | Internal Corner | RT27 |

| Product | Size | Code |
|---|------|-------|
| Over Fascia Ventilation 0.5 metre | | |
|  | 10mm | OFV10 |

| Product | Size | Code |
|---|------|------|
| Eaves protection system 1.5 metre | | |
|  | | EPS |

ROOFLINE, WINDOW & CLADDING SYSTEMS



Woodgrain PVC-UE Roofline Board and Soffit



Golden Oak (WG)



Black Ash (WB)



Rosewood (WR)



Anthracite Grey (WA)

| Product | Foil | Size | Code |
|---------|------|------|------|
|---------|------|------|------|

Universal Board - 9mm

Suitable as fascia (refurbishment - install over timber support), window board or reveal liner.

Single Leg

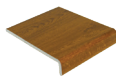

| | | |
|--|-------|------|
| | 150mm | U150 |
| | 175mm | U175 |
| | 200mm | U200 |
| | 225mm | U225 |
| | 250mm | U250 |
| | 300mm | U300 |

Double Leg

| | | |
|--|-------|------|
| | 454mm | U454 |
|--|-------|------|

Mammoth Board - 18mm

Suitable as fascia (replacement/new build install direct to rafters), window board or reveal liner.

Single Leg

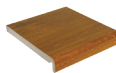

| | | |
|--|-------|------|
| | 150mm | M150 |
| | 175mm | M175 |
| | 200mm | M200 |
| | 225mm | M225 |
| | 250mm | M250 |

Double Leg

| | | |
|--|-------|------|
| | 404mm | M404 |
|--|-------|------|

Multi-Purpose Soffit Board - 10mm

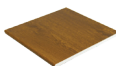

| | | |
|--|-------|------|
| | 100mm | S100 |
| | 150mm | S150 |
| | 175mm | S175 |
| | 200mm | S200 |
| | 225mm | S225 |
| | 250mm | S250 |
| | 304mm | S304 |
| | 404mm | S404 |

| Product | Foil | Size | Code |
|---------|------|------|------|
|---------|------|------|------|

Vented Soffit - 10mm

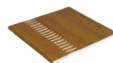

| | | |
|--|-------|------|
| | 150mm | V150 |
| | 175mm | V175 |
| | 200mm | V200 |
| | 225mm | V225 |
| | 250mm | V250 |
| | 304mm | V304 |
| | 404mm | V404 |

Double Vented Soffit - 10mm

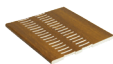

| | | |
|--|-------|-------|
| | 175mm | DV175 |
| | 200mm | DV200 |
| | 250mm | DV250 |
| | 304mm | DV304 |
| | 404mm | DV404 |

Vented soffit with a double row of vents is available to special order.

Hollow Soffit

To be used as a soffit only.

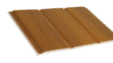

| | | |
|--|-------|------|
| | 300mm | H300 |
|--|-------|------|

Hollow Soffit Trims



| | | |
|--|-----|----|
| | 'J' | HJ |
|--|-----|----|



| | | |
|--|-----|----|
| | 'H' | HH |
|--|-----|----|

Box End Boards

| | | | |
|-----------------|--|-------|-------|
| Universal Board | | 454mm | UB454 |
| Mammoth Board | | 404mm | MB404 |



Window System Trims

The FloPlast range of Fascia and Soffits, when used in conjunction with the window system trims of quadrants and architraves, provide the means to achieve a high quality dry fix finish to window openings and rooms.

Our flat back 6mm pencil round range of architraves produce an aesthetically pleasing finish to your room. The product is suitable for internal and external use. It is traditionally used for skirting, covering broken plaster around windows and for joints around door linings.

Flexible angles 25mm, 35mm and 75mm wide, have a nitrile modified PVC joint and are suitable as a cover trim for bay window mullions for example.









During installation it is important that the products in the Window System Trims are fixed to a dry and sound substrate. Ensure that the profiles are mitred for external corners and scribe and cut for internal corners. All joints should be fixed using a suitable adhesive or silicone sealant.

Cellular PVC-UE has a thermal expansion similar to rigid PVC, so if secured correctly there should be no relative movement of individual profiles.

When used in accordance with the manufacturers instructions neoprene/rubber solutions, silicone sealant and anaerobic adhesives are suitable for the fixing of cellular PVC-UE trims.

FloTop Stainless Steel plastic headed nails provide a maintenance free fixing in some applications.



| Product | Size | Code |
|---|------------------------|------|
| Architrave-Pencil Round | | |
|  | 45x6mm | WT1 |
| | 65x6mm | WT2 |
| | 95x6mm | WT3 |
| D Section | | |
|  | 28x6mm | WT4 |
| Edge Fillet | | |
|  | 20mm | WT5 |
| Quadrant | | |
|  | 12mm | WT6 |
| | 19mm | WT7 |
| Square | | |
|  | 15x13mm | WT8 |
| Window Board Channel | | |
|  | 10x5mm | RT21 |
| Angle | | |
|  | 100x80mm 90° Hollow | WT30 |
|  | 25x25mm 90° Rigid | WT31 |
|  | 50x50mm 90° Rigid | WT32 |
|  | 25x25mm Flexi | WT36 |
|  | 35x35mm Flexi | WT37 |
|  | 75x75mm Flexi | WT38 |



Woodgrain Window System Trims



Golden Oak (WG)



Black Ash (WB)



Rosewood (WR)



Anthracite Grey (WA)

| Product | Foil | Size | Code |
|---------|------|------|------|
|---------|------|------|------|

Architrave-Pencil Round

| | | | |
|--|-------------|--------|-----|
| | WG WB WR WA | 45x6mm | WT1 |
| | WG WB WR WA | 65x6mm | WT2 |
| | WG WB WR WA | 95x6mm | WT3 |

D Section

| | | | |
|--|-------------|--------|-----|
| | WG WB WR WA | 28x6mm | WT4 |
|--|-------------|--------|-----|

Edge Fillet

| | | | |
|--|----------|------|-----|
| | WG WB WR | 20mm | WT5 |
|--|----------|------|-----|

Quadrant

| | | | |
|--|-------------|------|-----|
| | WG WB WR | 12mm | WT6 |
| | WG WB WR WA | 19mm | WT7 |

| Product | Foil | Size | Code |
|---------|------|------|------|
|---------|------|------|------|

Square

| | | | |
|--|----------|---------|-----|
| | WG WB WR | 15x13mm | WT8 |
|--|----------|---------|-----|

Angle

| | | | |
|--|----------|------------------------|------|
| | WG WB WR | 100x80mm 90° Hollow | WT30 |
| | WG WB WR | 25x25mm 90° Rigid | WT31 |
| | WG WB WR | 50x50mm 90° Rigid | WT32 |





Eaves Box Ends

The versatility and range of FloPlast profiles and accessories allows an extensive choice of detail and appearance when dealing with box ends. The illustrations detailed show some of the industry standard arrangements. Provision should be made for supporting all free edges of the box ends and box end returns as well as soffit boards. Treated softwood battens, securely fixed or tied back to the main structure, will provide a suitable means of support.

Box End Detail 1: Ogee Board fascia, and bargeboard cut from a section of fascia.



- The box end is usually deeper than the normal fascia run, because of this we offer our 454mm Universal and 404mm Mammoth boards in 1.25 mtr lengths.
- Use corner joints at the front and the back of the box end, and close the back of the box with a section of fascia (if this is deeper than the fascia, use the material supplied for the box end section) this should be slightly deeper than the measured height so that there is no gap between it and the bargeboard soffit.
- Cut the rear corner joint to suit.
- Where the back of the box end exceeds 300mm in height use the double ended 500mm Corner joint.
- Mitre the soffit at 45° and the soffit joint trim (RT20) at both ends.

Box End Detail 2: Mammoth Board fascia, bargeboard, and box end cut from a section of fascia.



- The box end is usually deeper than the normal fascia run, because of this, we offer our 454mm Universal and 404mm Mammoth boards in 1.25 mtr lengths.
- Use corner joints at the front and the back of the box end, and close the back of the box with a section of fascia (if this is deeper than the fascia, use the material supplied for the box end section) this should be slightly deeper than the measured height so that there is no gap between it and the bargeboard soffit.
- Cut the rear corner joint to suit.
- Where the back of the box end exceeds 300mm in height use the double ended 500mm Corner joint.
- The soffit is extended into the box end by butt jointing Multi Purpose Board cut to suit.

Box End Detail 3: Mammoth Board fascia, bargeboard, and box end cut from a section of fascia.



- The box end is usually deeper than the normal fascia run, because of this we offer our 454mm Universal and 404mm Mammoth boards in 1.25 mtr lengths.
- Use corner joints at the front and the back of the box end, and an In-line Joint between the bargeboard and the box end section. Close the back of the box with a section of fascia (if this is deeper than the fascia, use the material supplied for the box end section) this should be slightly deeper than the measured height so that there is no gap between it and the bargeboard soffit.
- Cut and mitre the rear corner joint to suit.
- Where the back of the box end exceeds 300mm in height use the double ended 500mm Corner joint.
- Mitre the soffit at 45° and the soffit joint trim (RT20) at both ends.



ROOFLINE, WINDOW & CLADDING SYSTEMS

Eaves Box Ends

Box End Detail 1a

Standard Ogee Board with a vertical cut end, fixed directly to the gable rafter

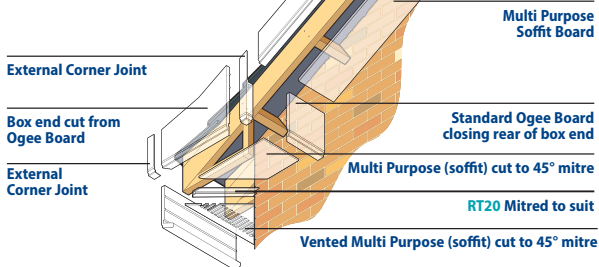

1b

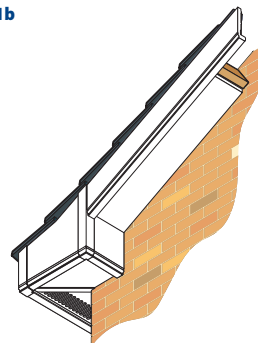

Box End Detail 2a

Mammoth/Universal Board with a vertical cut end, fixed directly to the gable rafter

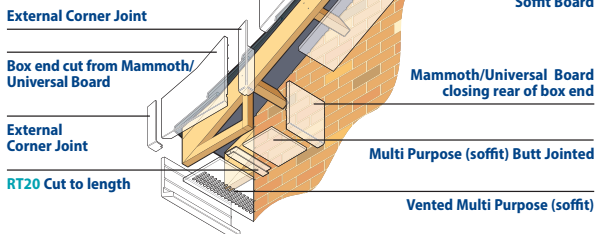

2b

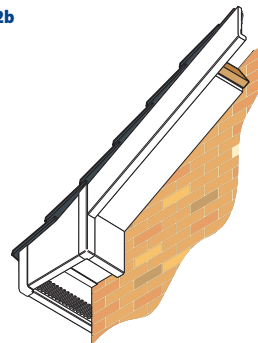

Box End Detail 3a

Mammoth/Universal Board with a square cut end, fixed directly to the gable rafter

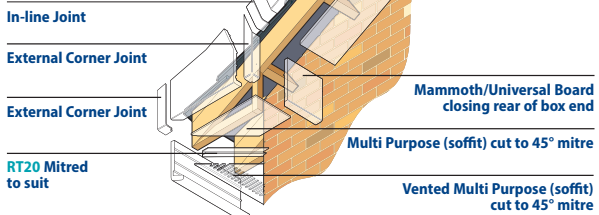

3b

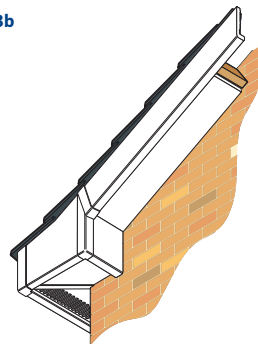



Eaves Box Ends and Decorative Bargeboard

Box End Detail 4: Mammoth Board fascia, bargeboard, and box end cut from a section of fascia.



- The box end is usually deeper than the normal fascia run, because of this we offer our 454mm Universal and 404mm Mammoth boards in 1.25 mtr lengths.
- Use corner joints at the front of the box end, a Board End Moulding to finish the rear edge of the box end, and an In-Line Joint between the bargeboard and the box end section.
- Close the back of the box with a section of fascia (if this is deeper than the fascia, use the material supplied for the box end section) this should be slightly deeper than the measured height so that there is no gap between it and the bargeboard soffit.

Box End Detail 5: Bargeboard extending to meet the fascia.



- A triangular fillet cut from a suitable piece of FloPlast board is set above the bargeboard, and fixed with FloTop nails to the tilt fillet on the gable rafter, another fillet, with either the return leg intact or removed, is fixed with FloTop nails to timber framing supported by the gable ladder, if the return leg is removed the bottom cut edge is protected by attaching a Board End Moulding. The triangular off cuts may be closely butt jointed and finished with low modulus silicone to the top and bottom edges of the bargeboard.
- Use corner joints at the front and the back of the box end cut to suit.
- Close the back of the box with a section of fascia (if this is deeper than the fascia, use the material supplied for the box end section) this should be lightly deeper than the measured height so that there is no gap between it and the bargeboard soffit.

FloPlast Decorative Bargeboard Moulding

The FloPlast Decorative Bargeboard Moulding offers style and character to most roofline installations. Once installed, it will require very little maintenance, as it will not rot, warp or require painting.

A variety of patterns can be achieved at the bargeboard apex, and two suggested examples are shown below. A finial joint is available to add that extra touch of elegance to your home.

Decorative Moulding Installation

Measure the length of your bargeboard and calculate how many mouldings are required at 500mm per moulding, making an allowance for design and plumb cuts at the ridge and barge ends.

Cut to size and screw using four 15mm x 6 self tapping screws, to the underside of the existing FloPlast PVC-UE bargeboard. Seal the joint between the moulding and bargeboard with either a low modulus silicone, or an appropriate adhesive.

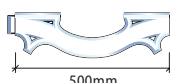



Eaves Box Ends and Decorative Bargeboard

Box End Detail 4a

Mammoth/Universal Board with a square cut end, fixed directly to the gable rafter

In-Line Joint

External Corner Joint

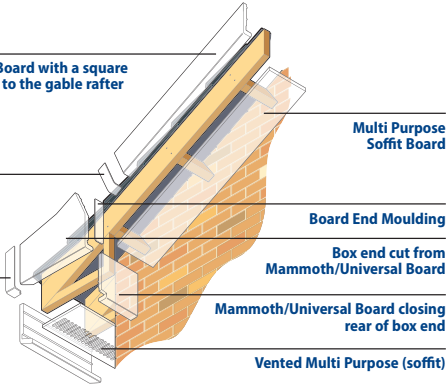

4b

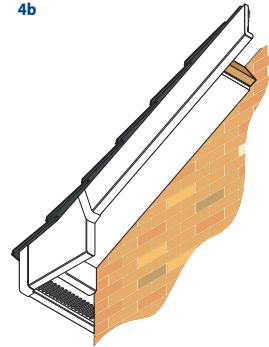

Box End Detail 5a

Mammoth/Universal Board with a vertical cut end, fixed directly to the gable rafter

External Corner Joint

Fillets cut from a suitable piece of FloPlast board

External Corner Joint

Alternative Board End Moulding

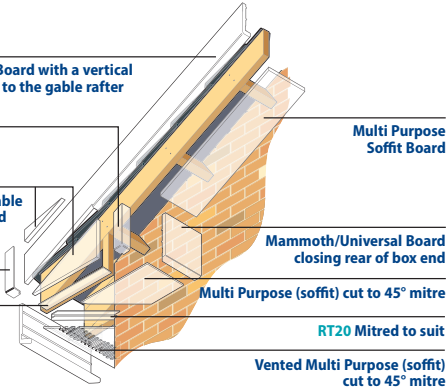

5b

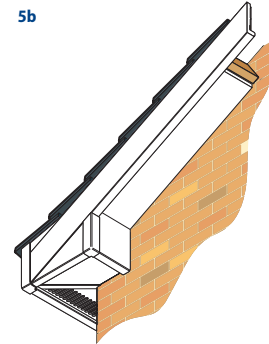

Decorative Bargeboard Moulding

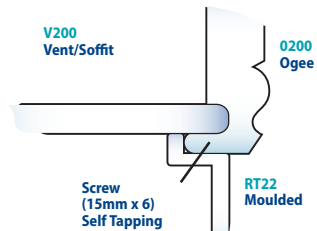
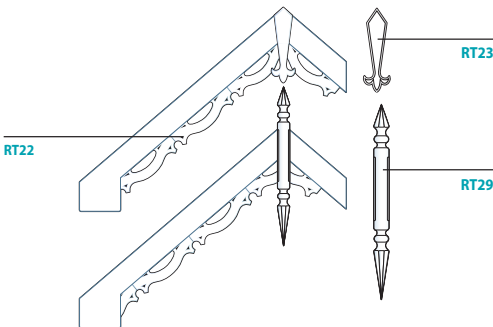



Installation Details

Refurbishment

Universal/Ogee Board and Multi-Purpose Soffit

The Fascia should have a suitable existing or new backboard. The universal/ogee board should be fixed so that the weight of the eaves course of tiles is distributed across the backboard and/or tilt fillets.

The soffit board should be supported on bearers at the foot of every rafter and be securely supported at each end. A preferred method is to support them by battens nailed or screwed to the rafters as shown in the diagrams. The bearers should be checked for line and level and suitable packing installed where necessary. All timbers should be treated with preservative.

When installing laminated woodgrain products, fixing centres should be reduced to a maximum of 400mm.

Eaves course of tiles taken up and replaced on completion

Sarking felt

Eaves Protection System

Universal Board fixed to existing sound timber fascia or min 12mm marine ply with 50mm FloTop nails

Multi-Purpose soffit fixed to bearers with 40mm FloTop pins at max. 600mm c/c

New Build/Replacement

Mammoth Board and Vented Soffit

When Mammoth Fascia is specified the roof covering should be supported by adequate means at the rafter ends. This can be by means of a tilt fillet, lay board or a shaped batten which extends the full length of the roof line. A lay board is particularly desirable in the case of pitches less than 30° as it will prevent any sagging of the Sarking felt.

Vented soffit boards are available in a range of sizes when roof ventilation via the soffit is specified. The boards fit into the groove of the Mammoth Board and should be fixed to suitable soffit bearers.

When installing laminated woodgrain products, fixing centres should be reduced to a maximum of 400mm.

Tilt fillet or batten

Sarking felt

Eaves Protection System

Soffit board engages between fascia/backboard and overcapping

Vented multi-purpose soffit fixed to bearers with 40mm FloTop pins at max. 600mm c/c



Installation Details

New Build/Replacement

(C) Mammoth Board and Multi-Purpose Soffit

It is not always necessary for the soffit to fit into the groove at the back of the Mammoth board. Diagram (c) shows a deeper Mammoth fascia, which has been chosen for design or appearance criteria, the Multi-Purpose soffit butts against the back of the Mammoth board and is fixed to each soffit bearer with two 40mm FloTop Pins.

When installing laminated woodgrain products, fixing centres should be reduced to a maximum of 400mm.

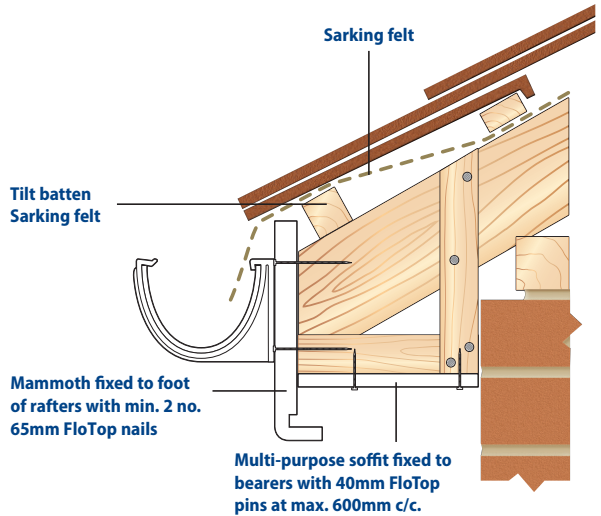

New Build/Replacement

(D) Mammoth Ogee Board and Vented Soffit

The diagram shows the Ogee style Mammoth Fascia; the appearance of this board makes it particularly favourable for the specifier and homeowner alike when trying to achieve a period appearance.

When used in conjunction with Decorative Bargeboard Mouldings and Niagara® gutter, an otherwise mundane appearance can be transformed into an aesthetically pleasing feature to a property.

When installing laminated woodgrain products, fixing centres should be reduced to a maximum of 400mm.

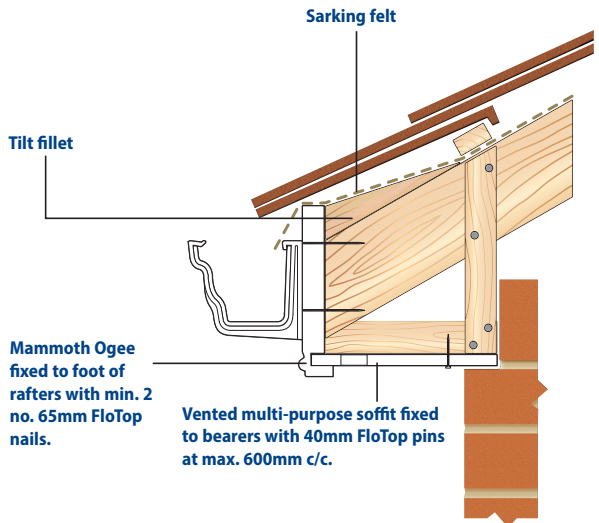



Cladding Systems BS EN 13245-2 Attestation Level 4



The FloPlast PVC-UE Cladding Systems are suitable for external use on buildings as a decorative and protective facing, fixed vertically, horizontally or diagonally over both brick, block, masonry and timber framed walling. When installed correctly this will reduce thermal loss by providing an additional external barrier.

Available in two designs (**Shiplap** and **Open Vee**) resembling existing timber profiles. The weather tight joint provided prevents penetration from the elements.

The systems are completed with a range of trims to suit all applications.

The tough and durable finish has a high impact strength and a weather resistant skin which requires little maintenance to retain its excellent appearance.

PVC Cladding Systems has been assessed and given an A+ rating, which allows the specifier/housebuilder to claim the code for sustainable homes maximum of three points when using PVC cladding on an external wall system.





For more information please refer to our BBA certificate 00/3772



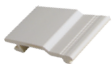

Performance in relation to fire

The system achieved a reaction to fire classification* of D-s3, d2/(AHM) to BS EN 13501-1 : 2007.

The system is not classified as non-combustible and may be used on buildings with no storey 18m or more above the ground and 1m or more from a boundary. With minor exceptions, the system should be included in calculations of unprotected area.

White PVC-UE Cladding Systems

| Product | Code |
|---|------|
| 100mm V Joint Cladding  | C100 |
| 150mm Shiplap Cladding  | C150 |
| Top Edge Trim (two part)  | CT1 |
| Starter Trim  | CT2 |

| Product | Code |
|---|------|
| Universal Channel  | CT3 |
| Drip Trim  | CT4 |
| Internal/External Corner (two part)  | CT5 |
| Centre Joint Trim  | CT7 |



Woodgrain Foiled PVC-UE Cladding Systems

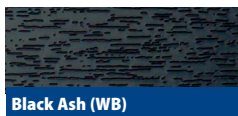

| Product | Code | Foil | Price* |
|--|------|----------|--------|
| 100mm V Joint Cladding | | | |
|  | C100 | WG WB WR | 83.38 |

| | | | |
|--|------|-------------|--------|
| 150mm Shiplap Cladding | | | |
|  | C150 | WG WB WR WA | 113.32 |

| | | | |
|--|-----|-------------|-------|
| Top Edge Trim (two part) | | | |
|  | CT1 | WG WB WR WA | 95.14 |

| | | | |
|--|-----|-------------|-------|
| Starter trim | | | |
|  | CT2 | WG WB WR WA | 51.30 |

| | | | |
|---|-----|-------------|-------|
| Universal Channel: | | | |
|  | CT3 | WG WB WR WA | 57.70 |

| Product | Code | Foil | Price* |
|---|------|-------------|--------|
| Drip Trims | | | |
|  | CT4 | WG WB WR WA | 57.70 |

| | | | |
|---|-----|-------------|--------|
| External Corner (two part) External corner foiled | | | |
|  | CT5 | WG WB WR WA | 143.25 |

| | | | |
|---|-----|-------------|--------|
| Internal Corner (two part) Internal corner foiled | | | |
|  | CT6 | WG WB WR WA | 143.25 |

| | | | |
|---|-----|-------------|-------|
| Centre Joint Trim | | | |
|  | CT7 | WG WB WR WA | 65.23 |





Cladding Installation

Horizontal Fixing

FloPlast 150mm Shiplap and 100mm V Joint Cladding, should be fixed at centres not exceeding 600mm. If installation is to be above second storey height, then this should be reduced to 400mm.

When installing laminated woodgrain products, fixing centres should also be a maximum of 400mm.

Working from a level line, the starter trim (A) is fixed to timber studs or battens using the specified 30mm cladding pins. All other framing trims are then fitted. Where two-part Trims are required (Top edge trim, or external and internal corners (B)), only the back half is fixed at this stage (C&D).

The bottom cladding plank is then located firmly in the starter trim and vertical trims, and fixed into place using the specified 30mm cladding pins, starting at one end, or working from the centre outwards. At the end of each plank a 5mm gap should be allowed for expansion.

Where necessary, trims and planks are cut to size and shape (e.g. along the verge) with a fine toothed saw.

Subsequent planks are fitted into the preceding planks, ensuring that the tongue-and-groove joint is firmly closed and nail heads are concealed.

If it becomes necessary to cut the top plank to fit the remaining space, then off cuts of Cladding should be placed behind the cut plank at each fixing centre.

Where sections longer than 5m are to be clad, Butt Joints of adjacent cladding planks should be concealed with an individual butt joint trim or by a centre Joint trim fixed to a batten or stud, and a 10mm expansion gap should be allowed between the planks. For aesthetic reasons the positioning of any centre Joint trims should be taken into account at the planning stage.

Where two-part trims have been used, fastening the front part of the Trim completes the installation.

If individual butt joint trims are used to join two or more cladding planks they should be spaced so that they do not impede the expansion of another butt joint above or below.

Bottom (Starter) edge detail (A) - Side Section

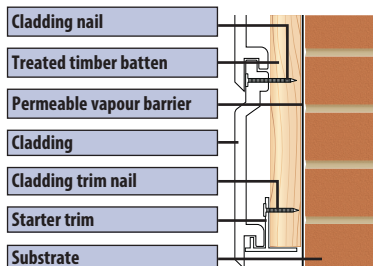

Bottom (Starter) edge detail (A) - Side Section

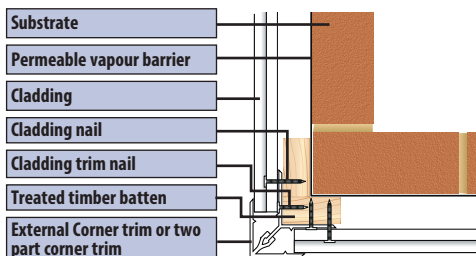

*Note: A horizontal-cladding batten must support the Top edge trim. At least 8mm clearance must be allowed between the top of the last plank and the inside of the male extrusion of the top-edge trim. This allows for the last plank to be located and thermal movement to take place.

Top edge detail (B) - Side Section

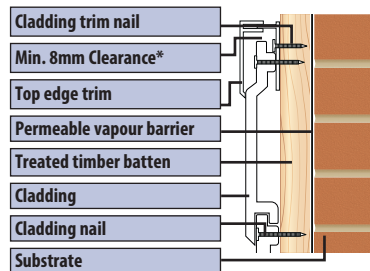

Top edge detail (B) - Side Section

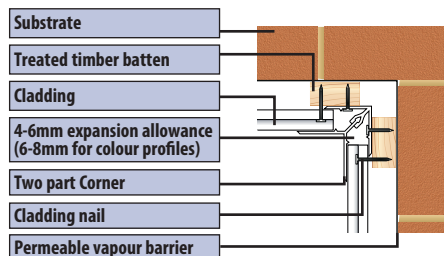



Cladding Installation



1. Fix perimeter frame and intermediate vertical battens to wall

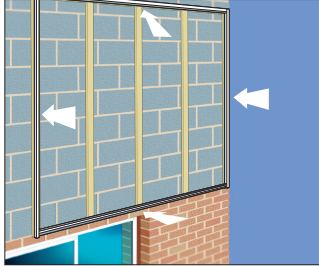

2. Fix all perimeter trims



3. Fit first plank at base



4. Fit remaining planks and engage male part of two-part trims



5. Ideal joint design when using individual butt joints.



Ventilation

A minimum clear air space of 38mm must be provided behind the cladding, and this can be achieved, by using 50 x 38mm recommended battens. If insulation material is used the gap must be kept clear to allow air to circulate at all times.

Weatherproofing

The FloPlast cladding system is not air or water vapour tight, but will withstand normal weather conditions owing to its interlocking joint. It is advised that when used on timber studding, or walls which are not fully weathertight or subject to exposed conditions, that the system should be backed by a vapour permeable membrane.

Requirements for drainage must be made to allow for any driving water that has penetrated. To achieve this 10mm holes should be positioned every metre in the horizontal lower batten.



Over Fascia Ventilation and Eaves Protection System

FloPlast offer a range of ventilation options which comply with the current Building Regulations 1991 (England and Wales) requirement F2, the Building Regulations (Northern Ireland) 1990 and NHBC recommendations.

The regulations are designed to limit condensation risks in a roof void constructed above an insulated ceiling.

Available in 1.5 metre lengths, Eaves Protection System can be used for refurbishment projects to replace rotted gutter felt and, in new build applications, it reduces long term eaves maintenance problems by directing water away from the underlay into the gutter. It also supports the underlay which prevents 'ponding' behind the fascia board.

Adjoining strips should be overlapped by 150mm and fixed at 200mm centres.

Over Fascia Vent Strip

Available with the equivalent of 10mm continuous air gap to suit current regulations. The 10mm is supplied in 5 metre packs, each section measuring 28mm H x 35mm D x 500mm L interlinks and has fixing points for ease of installation.

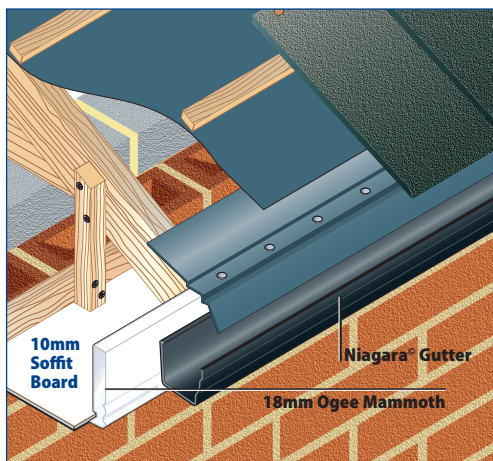





Because of the added height, when using over fascia ventilation, an allowance to reduce the size of the fascia board should be considered.

| Pitched Roof | Allowance |
|--------------|-----------|
| 0° - 50° | 10mm |
| 51° - 55° | 20mm |
| 56° - 60° | 30mm |
| 61° - 65° | 35mm |
| 66° - 70° | 40mm |

Over fascia vent strip has an integral inhibitor to exclude large insects and vermin from the roof void. 65mm x 3.35mm diameter galvanised steel nails, fixed at 200mm centres should be used to fix the Over Fascia Ventilation System.

Pre-vented Soffit boards are also available with the equivalent of 10mm and 25mm continuous air gap. The disc and soffit ventilator strips add variety and flexibility for the specifier and installer ensuring building regulations are met in all situations.

| Product | Size | Code |
|---|------|-------|
| Soffit Ventilator: | | |
|  | | RT24 |
| Disc Soffit Ventilator: | | |
|  | | RT25 |
| Soffit Ventilator with Mesh: | | |
|  | | RT27 |
| Over Fascia Ventilation & Eaves protection system | | |
| Over Fascia Ventilation:  | 10mm | OFV10 |
| Eaves Protection System:  | | EPS |



Technical Specification

Composition

FloPlast Cellular PVC Profiles are manufactured by a co-extrusion process in which a high impact PVC-U (unplasticised expanded polyvinyl chloride) compound is co-extruded onto the outer surface of a foamed PVC-UE Cellular Core, cooled and formed to section, then cut to length and width as required.

PVC-UE has a high degree of thermal insulation and is resistant to acids, alkalis, seawater and atmospheric pollution.

Maintenance

Cellular PVC components have a consistent self-finish and colour and are low maintenance. To restore to an 'as new' surface appearance, occasional washing with a non-scratch mild detergent and water will remove surface grime particularly in polluted atmosphere. Do not use solvents or abrasive cleaners.

Painting is not recommended as it can effect the impact strength of the product and the application of dark colours could lead to thermal distortion. However should painting be required for design or style considerations, use a good quality satin polyurethane paint.

Durability

The tough co-extruded outer skin provides excellent all year round weathering. Some natural shading over a number of years will occur due to the natural weathering process. Any slight colour change or surface dulling which might occur will be uniform over the visible exposed surfaces of the products and will remain an effective system for a period in excess of 35 years.

Site Work/Fixing

FloPlast products undergo rigorous quality control checks in the factory, during and after manufacture. Should there be any defect for whatever reason, it should be reported to FloPlast immediately to enable us to carry out an inspection.

The protective film on the co-extrusion should be removed just prior to fitting. Should a defect become apparent at this stage the product should not be fitted.

FloPlast Cellular Boards are easily cut, routed and drilled using conventional woodworking tools. Stainless steel pins/nails should be used for fixing.

Saws with fine-toothed blades should be used and power tools should be operated at the same or higher speeds to those normally used for timberwork, with carbide tipped blades. Ensure that a face mask and eye protectors are worn. Take additional care with the product close to or below freezing point, as low temperatures tend to make the product brittle. The product should not be fixed in temperatures above 25°C, or exposed to direct sunlight prior to fixing which may cause thermal distortion.

Correct fixings and fixing procedures should always be followed and the product secured to a sound substructure.

A 10mm gap must be provided for thermal expansion at joints and plank ends.

Behaviour in relation to fire:

■ Boards

The cellular boards achieve a Class 2Y surface-spread-of-flame rating when tested in accordance with BS 476-7.

■ Hollow Soffit

The hollow soffits achieve a Class 1Y surface-spread-of-flame rating when tested in accordance with BS 476-7

■ Foiled Products

The Renolit foil applied to FloPlast's cladding, boards or hollow soffit systems has been tested and achieved the following fire rating:

When tested in accordance with DIN4012-B2 and DIN EN ISO13501-1, the requirements according to RAL-GZ716/1 Section I Part 7 are fully met.

General

On exposure to fire, PVC-U tends to char and may fall away. The spread of flame along its surface is limited. It is unlikely that the roof trim system will significantly affect the overall fire performance of any roof in which it is installed.

Where it is normal practice to carry the eaves box over, between dwellings, it is important that the box is fire-stopped at compartment walls with a proprietary fire stop material.

PVC-UE Fascia soffit and cladding should not be installed on applications above 18mtrs in height.



General Information

Transport, Handling and Storage

FloPlast products are wrapped in polythene sleeving in specified pack quantities to guard against damage during transportation and storage. Care should be taken in their handling and they should be stored in stacks not exceeding one metre in height.

It is important that products are stored flat and fully supported on a firm base at temperatures below 30° C. Screen from direct sunlight to avoid rapid build-up of temperatures inside polythene sleeves.

The co-extruded surfaces are protected by a polythene film which should be removed just prior to installation.

Quality Control

FloPlast Cellular and rigid boards are manufactured within a quality management system which has been assessed by BSI and complies with the requirements of BS EN ISO 9001:2015 (Certificate no. FM501414).

Continuous quality control procedures are in place during and after manufacture to check appearance, dimensions, weight per metre, heat reversion, heat ageing and impact strength.

Terms and Conditions of sale

Goods are sold subject to our Standard Terms and Conditions of Sale, which are available upon request. FloPlast Limited reserves the right to modify or extend any product range or published information without prior notice.

Model Specification

Fascias, Soffit's and Bargeboards are to be constructed using FloPlast Cellular and Rigid PVC Roof Trim System Profiles manufactured in accordance with BS7619 - Cellular PVC-UE, approved by the British Board of Agrément 00/3771 and within the requirements of BS EN ISO 9001.

Boards are white or have a woodgrain effect laminated finish and fixing should be in accordance with normally accepted practice. Boards are to be fixed using plastic-

Summary

- Boards to be fixed only at temperatures above 5°C and below 25°C.
- Fixings at a maximum of 600mm (400mm for cladding above two storey height, and laminated woodgrain products).
- Secure boards to sound timber only replacing any rotten timber with new treated softwood.
- Use adequate length of nails/pins.
- A 5mm gap to be allowed for thermal movement at joints and at box ends.

FloPlast Fascia Systems are not load bearing

- Eaves tiles should be adequately supported.
- Provide ventilation to roof space in accordance with current Building Regulations.
- Use eye protection when using power tools to cut or drill boards.
- Leave a clear air space of 38mm behind the Cladding.
- Ensure battens for Cladding are secured to a firm substrate.
- Remove all offcuts and dispose of environmentally.

headed stainless steel nails of an appropriate length, and secured to rafter feet, noggins and gable ladders.

Old Fascias, Soffit's and Bargeboards should preferably be removed, existing timber rafters and supports are to be inspected, and any rotten timber replaced with new treated softwood.

The Sarking felt should be examined, and replaced if any signs of damage or wear are found.



Fixing Details

Fascia (I) - Universal/Ogee Board are to be constructed from Universal/Ogee Board with a nominal thickness of 10mm or Hockey Board with a nominal thickness of 9mm, secured at 600mm centres, to treated battens or a backing board, with 50mm plastic-headed nails, with a minimum of 2 fixings per centre. 400mm centres for laminated woodgrain.

Joints to be supported and made at rafter feet, with both ends fixed, leaving a 10mm air gap and be covered with a joint trim, secured in position with Silicone Sealant, a proprietary adhesive or pins.

Gutter brackets are fixed through the Fascia into supporting timberwork, normally the rafter feet or backing board, with 40mm x 10 stainless steel screws.

Fascia (II) - Mammoth/Ogee Mammoth Board are to be constructed from Mammoth/Ogee Mammoth Board with a nominal thickness of 18mm or Mammoth Bullnose Fascia with a nominal thickness of 16mm, secured at 600mm centres to rafter feet with 65mm plastic-headed nails, 400mm centres for laminated woodgrain with a minimum of 2 fixings per rafter.

Joints to be supported and made at rafter feet, with both ends fixed, leaving a 10mm expansion gap and be covered with a joint trim, secured in position with Silicone sealant, a proprietary adhesive or nails.

Gutter brackets are fixed through the Fascia, with 40mm x 10 stainless steel screws.

Bargeboards (I) - Universal/Ogee Board are to be constructed from Universal/Ogee Board with a nominal thickness of 10mm or Hockey Board with a nominal thickness of 9mm, secured at 600mm centres to noggins and gable ladders with 50mm plastic-headed nails, with a minimum of 2 fixings per centre. 400mm centres for laminated woodgrain.

Joints are to be supported and secured as per Fascia Boards detail.

The ridge is to be joined using an appropriate trim with boards cut to the required angle.

Bargeboards (II) - Mammoth/Ogee Mammoth Board are to be constructed from Mammoth/Ogee Mammoth Board with a nominal thickness of 18mm or Mammoth Bullnose Fascia with a nominal thickness of 16mm, secured at 600mm centres to noggins and gable ladders, with 65mm plastic-headed nails, with a minimum of 2 fixings per centre. 400mm centres for laminated woodgrain.

Joints are to be supported and secured as per Fascia boards detail.

The ridge is to be joined using an appropriate trim with boards cut to the required angle.

Soffits - Multi-Purpose Board/Hollow Soffit/Cladding Soffit are to be constructed from PVC-UE Multi-Purpose Board, Rigid PVC-U Hollow Soffit or Cladded Soffit, and secured at 600mm centres to timber eave hangers, noggins or underside of rafters with 40mm plastic-headed nails, with a minimum of 2 fixings per centre, and 30mm stainless steel nails for Cladded profiles. 400mm centres for laminated woodgrain.

Soffit corner returns are made by cutting the boards to the appropriate angle and joining with an 'H' Trim. Soffit widths are not to exceed 200mm unsupported.

Extra widths are to be joined using a Longitudinal Coupling Trim, leaving a 5mm gap at each end for thermal expansion. Soffits are to be positioned on the cover board lip or secured within the Fascia groove of Mammoth Board, butt jointed with a 5mm gap at each end for expansion and secured by trim.



FloPlast

building the future

Contact Details:

FloPlast Limited
 Castle Road
 Eurolink Business Park
 Sittingbourne
 Kent ME10 3FP
 UK

Tel

01795 431731

Sales Office Direct Line

01795 421422

Fax

01795 431188

E-mail

sales@floplast.co.uk

Website

www.floplast.co.uk



April 2020

Brochures available:

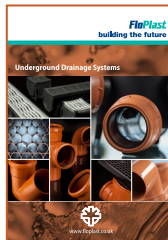
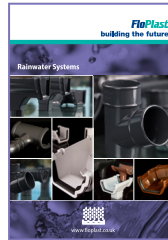

Roofline, Window and Cladding Systems



Rainwater Systems



Soil & Waste Systems



Underground Drainage Systems



MDPE Systems



Hot & Cold Plumbing Systems